

1991 / 1994 ADA Standards - Plan Review Tools - Plumbing Fixtures

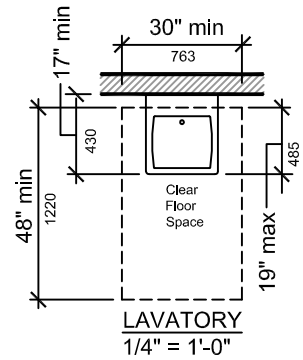

NOTE: some State requirements are more stringent than the ADA Standards - verify requirements in your State

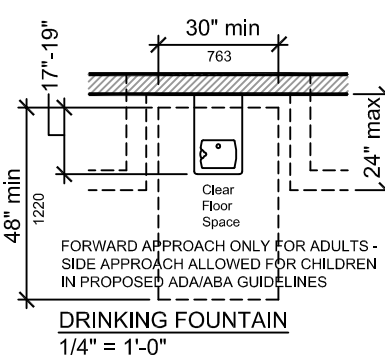
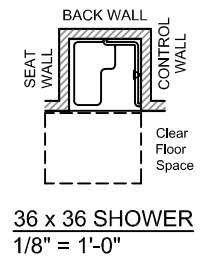
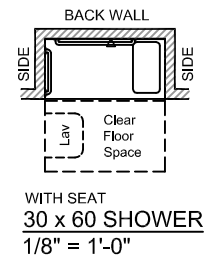
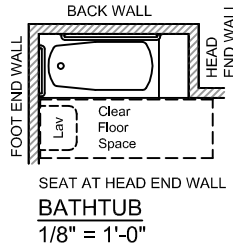
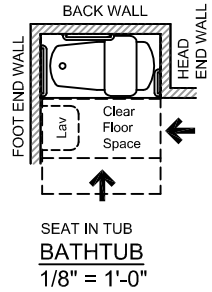
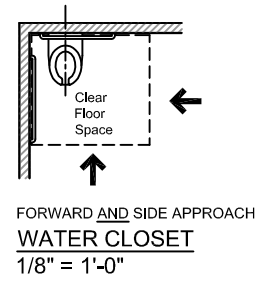
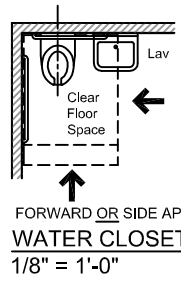
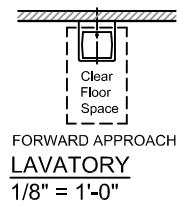
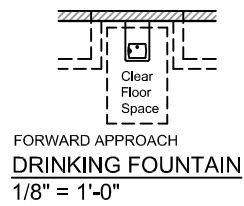
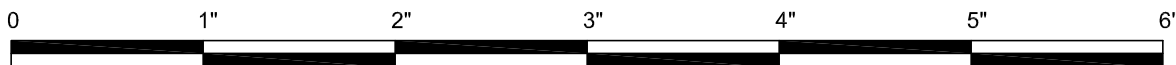
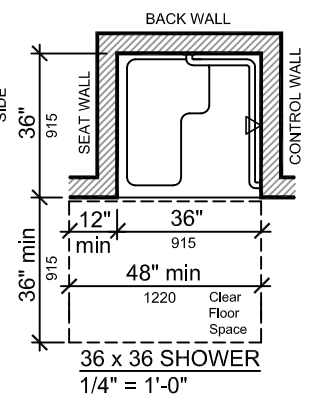
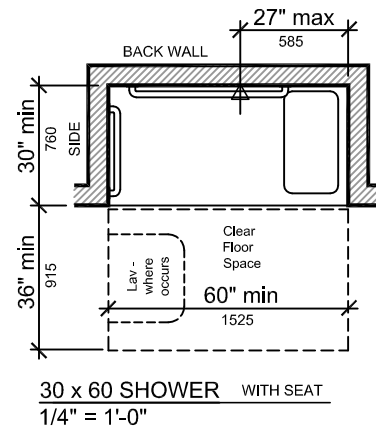
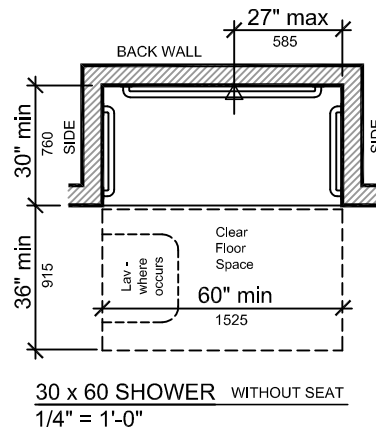
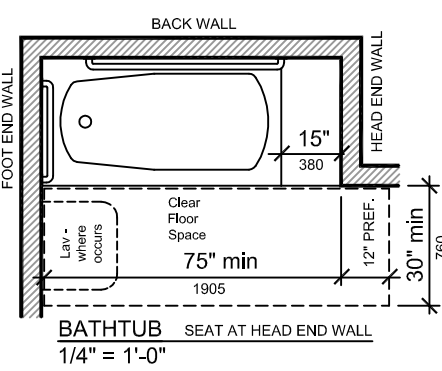
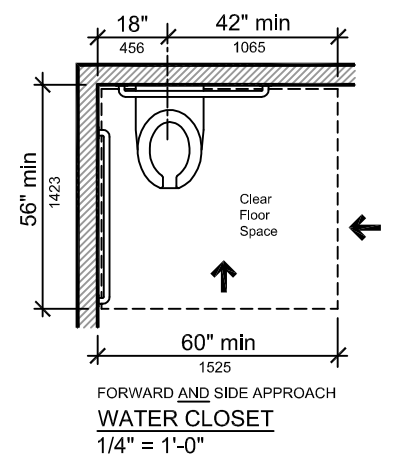
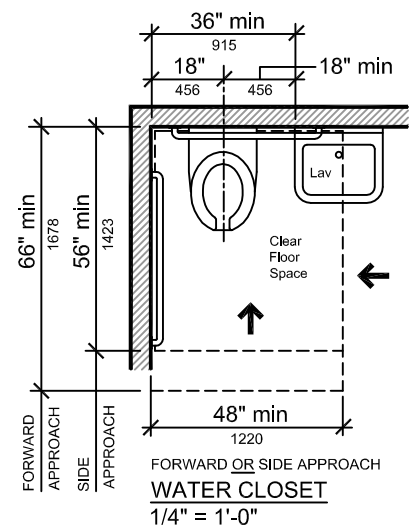
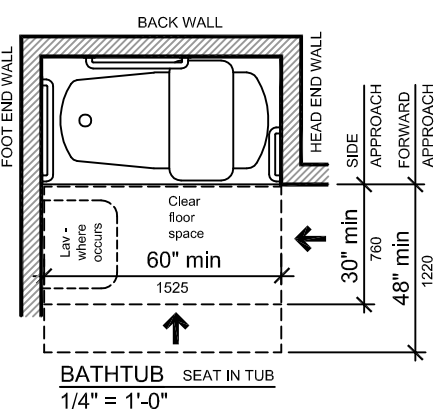

Actual Size Graphic Scale